



Monitor

User Manual

SM-U841

NOTICES

COPYRIGHT AND TRADEMARKS

Copyright © 2015 IDIS Corporation. All rights reserved.

All brand names and product names are trademarks, registered trademarks or trade names of their respective holders.

General

Every effort has been made to ensure accuracy, however in some cases changes in the products or availability could occur which may not be reflected in this document. We reserves the right to make changes to specifications at any time without notice. Performance specifications are typical, but may vary depending on conditions beyond our control such as maintenance of the product in proper working conditions. Performance specifications are based on information available at the time of printing. We makes no warranty of any kind with regard to this material, including, but not limited to, implied warranties of fitness for a particular purpose. We will not be liable for errors contained herein or for incidental or consequential damages in connection with the performance or use of this material. Our manufacturing facility is ISO 9001 and 14001 certified.

REGULATORY

The product has been tested and found to comply with the limits for a Class A digital device, pursuant to Part 15 of the FCC Rules. These limits are designed to provide reasonable protection against harmful interference when the product is operated in a commercial environment. The product generates, uses, and can radiate radio frequency energy and, if not installed and used in accordance with the instruction manual, may cause harmful interference to radio communications. Operation of the product in a residential area is likely to cause harmful interference in which case the user will be required to correct the interference at the user's own expense.

CAN ICES-3 (A) / NMB-3 (A)

In Finland: "Laitte on liitettävä suojakoskettimilla varustettuun pistorasiaan"

In Norway: "Apparatet må tilkoples jordet stikkontakt"

In Sweden: "Apparaten skall anslutas till jordat uttag"

In Denmark: "Apparatets stikprop skal tilsluttes en stikkontakt med jord, som giver forbindelse til stikproppens jord."

Environmental

The product is designed and manufactured with high-quality materials and components that can be recycled and reused. This symbol means that electrical and electronic equipment, at their end-of-life, should be disposed of separately from regular waste. Please dispose of the product appropriately and according to local regulations. In the European Union, there are separate collection systems for used electrical and electronic products. Please help us to conserve the environment we live in!

Table of Contents

1	BEFORE USING THE PRODUCT.....	4
1.1	SAFETY PRECAUTIONS.....	4
2	PREPARATIONS.....	11
2.1	PARTS LIST.....	11
2.2	CONTROL PRODUCT	12
2.3	INPUT/OUTPUT CONNECTION.....	14
2.4	REMOTE CONTROLLER BUTTON DESCRIPTION.....	16
3	INSTALLATION GUIDE	17
3.1	CAUTION BEFORE INSTALLATION.....	17
3.2	PRODUCT SPECIFICATIONS	17
3.3	UNPACKING PROCESS	18
3.4	HANDLING GUIDE	19
3.5	PRODUCT INSTALLATION	21
3.6	WALL MOUNTING INSTALLATION	21
3.7	REMOTE CONTROLLER	22
3.8	SETUP.....	23
4	REMOTE CONTROL.....	24
4.1	RS-232C CONNECTION.....	24
4.2	COMMUNICATION COMMAND	25
4.3	COMMUNICATION COMMAND LIST	27
5	CONNECT THE EXTERNAL DEVICE.....	28
5.1	DP (DISPLAY PORT) CONNECTION	28
5.2	HDMI CONNECTION	29
5.3	DVI-D CONNECTION	30
5.4	VGA CONNECTION	31
6	MENU CONTROL.....	32
6.1	INPUT SELECTION.....	32
6.2	PICTURE ADJUSTMENT.....	32
6.3	SOUND ADJUSTMENT	34
6.4	OSD ADJUSTING	35
6.5	ADJUSTING SETTING	36
6.6	INFORMATION	37
7	TROUBLE SHOOTING	38
8	PRODUCT SPECIFICATION.....	41
9	SUPPORTED RESOLUTIONS	42
10	REQUIRED INFORMATION	43
10.1	PREVENT IMAGE STICKING.....	43

1 Before using the product

- Before installing or using the product, to avoid damaging the product, read and follow as the guidelines of the user manual for your safety.
- The color, design and specification may change without notice to enhance the function.

1.1 Safety Precautions

Precautions are divided into two "Warning" and "Caution", and meaning of the each is as follows.



Warning: If you do not follow, it could result in serious injury or death.



Caution: If you do not follow, it could result in minor injury or product damage.

Please keep users to access **USER MANUAL** easily.



This illustration below is for reference only.



Warning



Do not use a damaged power cable or plug which does not meet the standard.
- This may cause a fire or an electric shock.



If you are using a power strip, do not use several devices at the same time.
- Due to the heat generated by the multi-outlet, it may cause fire.



Do not touch the power plug with wet hands.
- This may cause an electric shock.



Plug in the outlet end exactly.
- If the connection is not stable, it may cause fire.



Connect the power cable to a grounded outlet.
- This can cause electric shock when the ground is broken or shorted.
- When installing on a place that cannot be grounded, connect to the outlet by using a circuit breaker to protect the product from electric shock.



Do not pull or bend the power cable forcibly.
Avoid placing heavy objects on the cables.
- If the cable is damaged, it may result in electric shock or a fire.



Do not use the power cable near heating appliances and products.
- This may cause a fire or electric shock.



In case of contamination around the power plug or outlet, wipe clean with a dry cloth.
- This may cause a fire.



Do not place flammable objects near the product.
- This may cause a fire.



If you want to install by using the wall mount, make the product be installed by a trained technician. Refer to the User Guide Wall Mounting.
- This may cause injury.

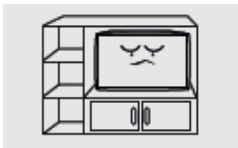

Do not install the product in poorly ventilated places such as a bookshelf or closet.
- Otherwise it may affect internal temperature to be increased and cause a fire.



Install the product at least 10 cm far from the wall.
- Otherwise it may affect internal temperature to be increased and cause a fire.



After unpacking the product, packaging vinyl should be kept away from the hands of young children.
- If a child use it incorrectly, it may cause a choking accident.



Do not install in locations where has vibration or in an unstable position.
- Product fall may occur and it might cause a damage.
- This may cause a fire.

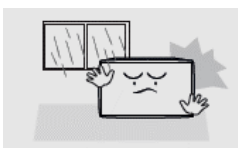

Do not install in places which dirt, moisture, smoke, much water or rain water can reach.
Do not install under the air conditioner that could fall water drops.
- This may result in electric shock or fire.



Avoid exposure to direct sunlight and do not place near hot objects such as a fire or heater heat.

- This may cause a fire or shortening the product life.



Do not install in the low place where a child can touch.

- A child may be injured while playing and touching the product.



Do not install near any kitchen or kitchen counter because it may cause damage or deformation of the product by the vapor or oil.

- This may cause a fire.



Do not try to repair or transform the product because the high voltage can flow inside the product.

- This may cause a fire or electric shock.
- When problem is found in the product, contact a service center.



Do not use electrical equipment which uses high-voltage around the product.

- This may result in poor quality of display or cause amblyopia.
- This may cause a fire or electric shock.



When moving the product, turn off the power and remove all of the cables including power cables connected to the product.

- If the cable is damaged, it may cause a fire or electric shock.



When smelling something burning or hearing strange sound from the product, disconnect the power cable immediately and contact a service center.

- This may cause a fire or electric shock.



Do not allow a child to get on or hang on the product.

- If the product falls off, a child may result in injury or death.



Do not place heavy object, toy or sweets that a child can play with on the product.

- If a child hang the product and fall, it may cause personal injury or death.



When the product is damaged or falls off, disconnect the power cable immediately and contact a service center.

- This may cause a fire or electric shock.

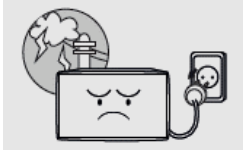

When lightning occurs, turn off the power switch and disconnect the power cable.
- This may cause a fire or electric shock.



Do not drop the product or throw something to the product.
- This may cause a fire or electric shock.



Do not give a shock or scratch to the screen with sharp objects.
- This may cause damage to the product.



Do not pull the power cable or signal cables connected to the product when moving the product.
- Cable damage may cause a malfunction or an electric shock or fire.



Do not shake or uplift a product by holding only the power cable and signal cable.
- Cable damage may cause a malfunction or an electric shock or fire.



If you smell a gas around the place of the product or there is a risk of a gas leakage, Do not plug in or turn on the product. Make sure to ventilate.
- A spark in the appliance power can cause an explosion or fire.



Do not store or use flammable material and flammable sprays near the product.
- This may cause an explosion or fire.



Please do not block a vent with the curtain or cloth, etc.
- The rise of internal temperature may cause a fire.



Do not put a steel rod, coin, hair pin etc. in the vent and input/output terminals of the product.
Also, do not put a flammable object such as papers.
- When a strange substance enters into the product, turn off the power of the product. Please contact the Service Center after unplugging the power cable.
- This may cause a malfunction or an electric shock or fire.



Do not place anything containing liquid or metals on the product.
- When a strange substance enters into the product, turn off the power of the product. Please contact the Service Center after unplugging the power cable.
- This may cause a malfunction or an electric shock or fire.

Caution



Do not unplug the power cable while using the product.
- This may cause a fire or electric shock.



Use only the power cable qualified for the standard.
- This may cause a fire or electric shock.



Connect the power cable to the nearest outlet.
- If having a problem with the product, unplug the power cable completely.



When disconnecting the power cable from the outlet, do not pull the cable wire.
Please be sure to hold the plug and separate it.
- This may cause a fire or electric shock.

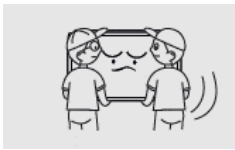

Please move the product carefully not to occur the twist and drop.
- This may cause a malfunction or injury.

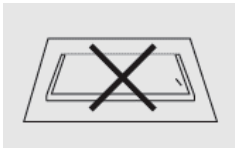

Put the product's screen faces upwards.
- The screen may be damaged.



Work together more than one person if the product is heavy.
- This may cause a malfunction or injury.



When installing the product on a cabinet or shelf, use the larger size of the tray than the product to use and maintain the horizon.
- The product may fall and cause damage or injury.



Please do not shock when installing the product.
- This may cause a malfunction.

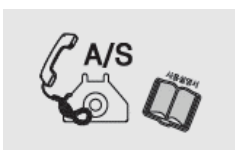

When installing the product in a special place, contact a dealer or a service center because the peculiar environment can occur the event of a problem with the product.
- This may cause a malfunction or fire.



Turning on the product in the condition of the fixed screen or 4:3 screen for a long time may also cause an afterimage or stain on the screen.

- When using the product for a long time, set a screen saver of the connected computer or signaling equipment products or set it in sleep mode.

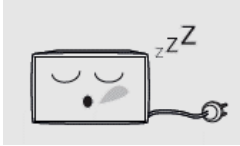

When you are not using the product for a long time, after unplugging the power cable and take action to prevent the product from a dust.

- Dust accumulation, heat generation or sparks can occur and cause fire.



Set a resolution and frequency appropriately to the product.

- The state of the screen can result in poor or blurred vision.



For products with a stand, do not move the product by holding only the stand or lift the product upside down.

- The stand might be split from the product and it may cause damage or injury.

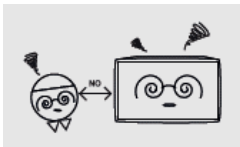

Look at the screen from a distance of about longer 2.5 times than the screen diagonal length.

- Looking at the screen for a long time can lead to vision loss.



Do not use anything that causes the water vapor near the product. (moisturizers, etc.).

- This may cause a malfunction or an electric shock or fire.

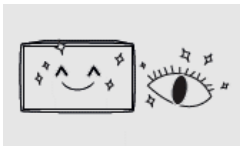

After 1 hours use, rest your eyes for more than 5 minutes.

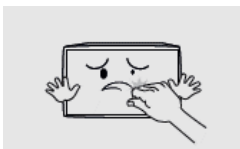

If the product is turned on for a long time, do not touch the screen surface or vent because it may be hot.



Keep the accessories of the products out of reach of children.

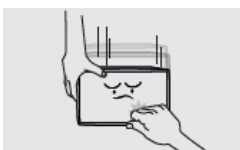

For products with a stand, be careful when adjusting the angle and height of the stand of the product.

- Tilting severely the product may cause the product to fall off and injury.
- Stuck a finger or hand may cause an injury.



Do not place heavy objects on the product.
- This may result in a malfunction or an injury.

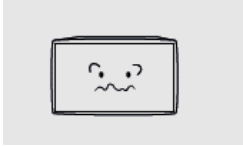

Please put obstacles away from the space between the remote controller and the product.
- The product may not be operated by remote controller.

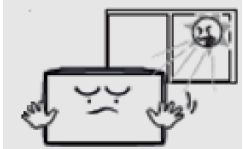

The remote control may not be good in this operation under the sun or strong light.
Please change the location of the product in this case.

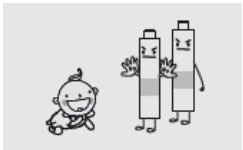

Make sure that a child does not eat the battery and keep it out of a child's reach.
- If a child eats the battery, please consult a doctor immediately.

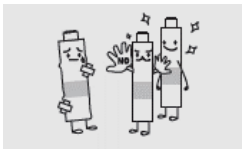

When replacing the battery, insert it to the correct polarities (+, -).
- If it is different from the polarity of the battery, it may cause a fire or injury to break or leak.
- This may also contaminate the surrounding.

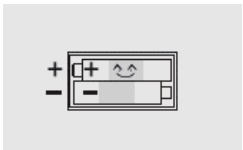

Use a standard battery, do not mix old batteries with new one.
- If it is different from the polarity of the battery, it may cause a fire or injury to break or leak.
- This may also contaminate the surrounding.



The depleted Battery and rechargeable batteries must be handled separately from the general waste and it needs to be collected for recycling.
- If the end-of-life battery, please bring your nearest recycling center or battery dealer
- This may cause an explosion or fire.

Cleaning



After disconnecting the power cable, wipe contaminated parts and each part of the product screen lightly with a dry and soft cloth.

Do not clean the product directly with a wet cloth or wet spray water.
- There is a risk of fire or an electric shock.

When washing by various cleaning agents, brighteners, abrasives, waxes, benzene, alcohol, solvent, surface active agent, the surface of the product may be damaged.





If cleaning inside the product is required, please contact your dealer or service center.
- This may result in fire or electric shock.

2 Preparations

2.1 Parts List

 If these items are missing, contact your dealer or service center.

 The following images may differ from the image shown.

 Other parts not packed in contents may cause performance degradation or problem during use.



HDMI Cable



Power Cable
(Option)



Remote
Control



AAA 1.5V
Battery x 2



IR Receiver



Screw x 2
(3M x 6L)



RS232 Cable





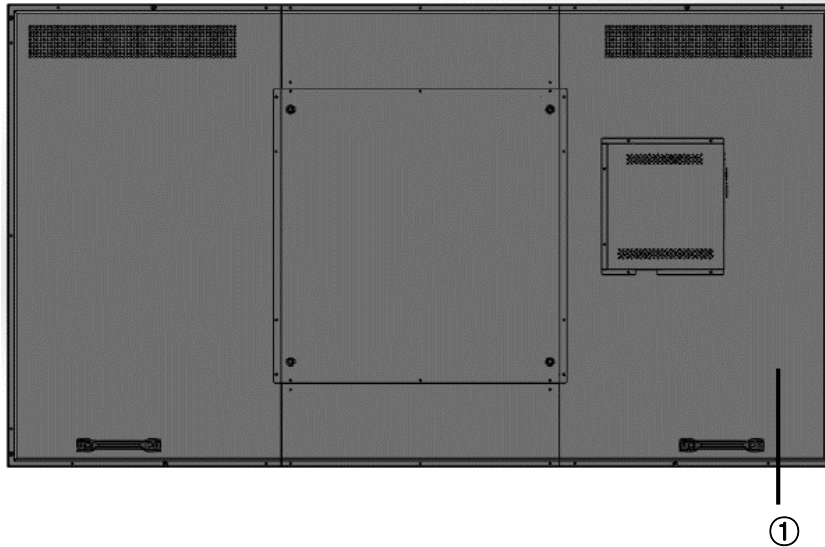

2.2 Control product

 The following images may differ from the image shown.

- You can control the product by using the control buttons on the rear side of the product.



Control buttons - ①

	Power on/off button
	To move to the upper menu or select
	To move to the lower menu
	To move to the right menu or turn up the volume.
	To move to the left menu or turn down the volume
	To display or hide the on-screen menu

Installation of an external remote controller receiver

1. The included external remote sensor should be fixed to external remote sensor on the product by using two screws on the bottom of the left of the front panel.

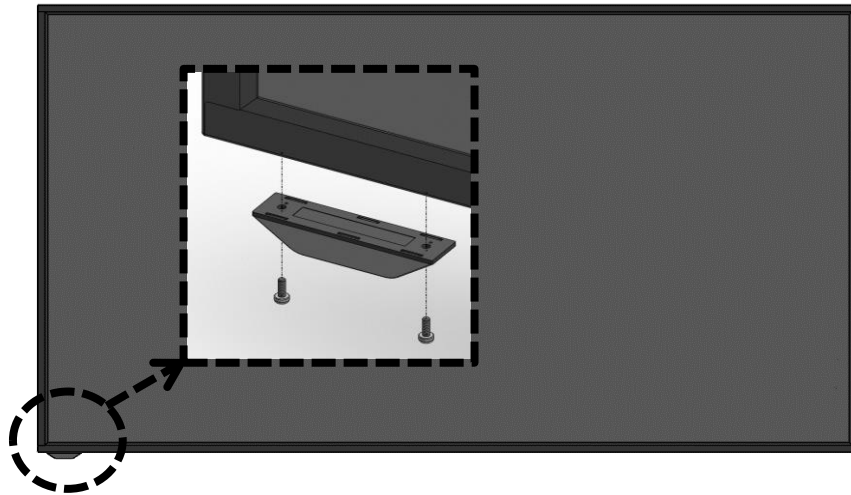

2. Connect the cable of the external remote controller receiver to IR In connector.

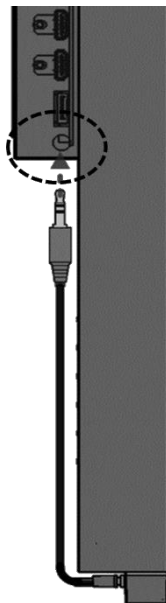

Remote Sensor / Power indicator

Power on	Green
Stand-by	Red
Power Saving (Eco)	Red
Power Saving (Eco)	Orange or Red/Green Blinking

2.3 Input/Output connection

 The items may differ from the image shown.

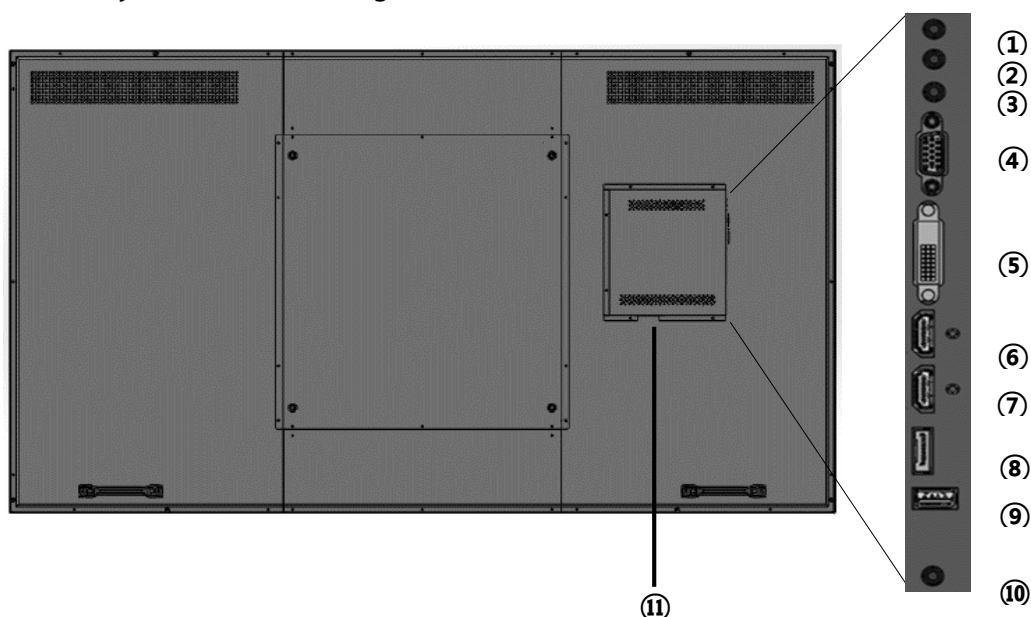

Connector name and description

No.	Connector	Description
①	RS-232C In	To connect RS232 input cable with control device (3.5Φ)
②	Audio Out	To connect audio stereo output (3.5Φ)
③	Audio In	To connect audio input (3.5Φ)
④	VGA In	To connect VGA video input
⑤	DVI-D In	To connect DVI-D video input
⑥	HDMI 1 In	To connect HDMI 1.4b video & audio input - 1
⑦	HDMI 2 In	To connect HDMI 1.4b video & audio input - 2
⑧	DP In	To connect 2DisplayPort 1.1a video & audio input
⑨	Service In	To connect with USB device for software update
⑩	IR In	To connect external remote controller transmitter input (3.5Φ)
⑪	Power Input	Power connector (AC 100-240V, 50/60Hz) or Power Switch (O: AC off, —: AC on)

 Caution

- When you connect the signal cables to the input / output terminals, check the above picture of the input / output terminal, and connect in the right direction. If connected incorrectly, it may cause damage or breakdown of the input / output terminals.
- If the product does not operate even though the power is supplied, check if the power switch is set to power-on or not.

2.4 Remote Controller Button Description

Button Description

 The following images may differ from the actual items.

 Button not described does not work.

POWER	Power on/off button
SOURCE	Select input signal
▲	Move to the upper menu
▼	Move to the lower menu
SEL	Select to change menu
◀	Move to the left menu or turn down the volume
▶	Move to the right menu or turn up the volume
MENU	Display or hide menu on the screen
INFO	Display information of input source and program version
MUTE	Not available
AUTO	Automatically adjust VGA position, clock and phase (RGB input only)



3 Installation Guide

3.1 Caution before installation

 **Caution:** Installation must be performed by a qualified custom video installation specialist under the conditional installation environment as below.

Ambient Lighting

- When the sun or strong light shines on the front screen of the product, image contrast can be seen as it is decreased conspicuously or the image is fading.
- If direct sunlight or strong artificial light (halogen lamps, etc.) shines on the front screen of the product (if the product has touch function, it may cause of malfunction of touch.), install the product in the shady environments or in the opposite direction of the source of the sunshine or the artificial light.

Ambient temperature

- Install the product in the well-ventilated place with maintaining the ambient temperature of below 35° C (95° F).

3.2 Product Specifications

Height	1,102.0 mm (✎ except for external remote sensor)
Width	1,910.0 mm
Depth	90.5 mm
Weight	68 ± 2 kg

3.3 Unpacking Process

 The following mages may differ from the actual items.
Before unpacking the box, refer to the diagram below.

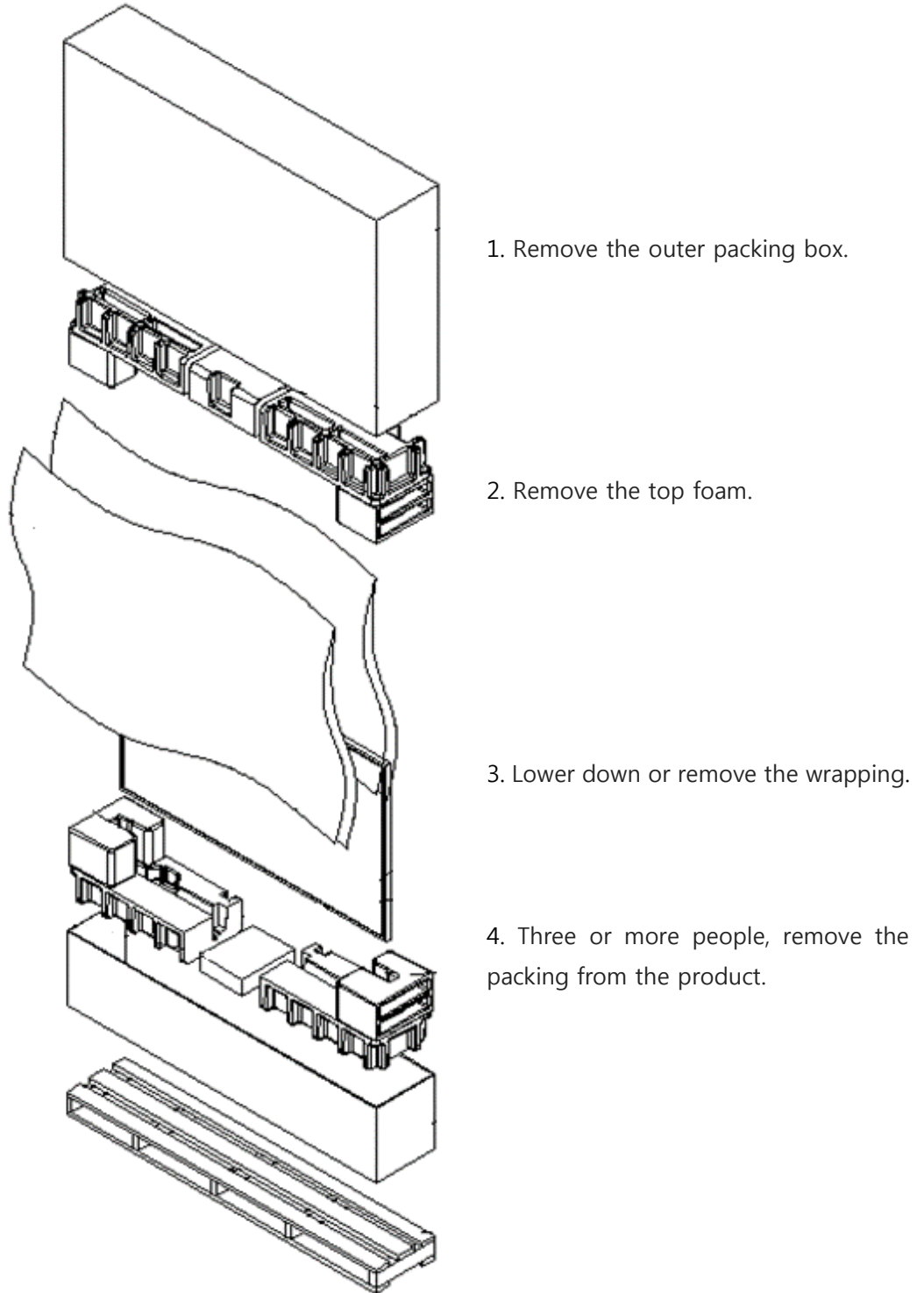

3.4 Handling Guide

 The following mages may differ from the actual items.

Holding a product

1. Right way

At least two persons are required to handle the product during transportation.

Two persons should hold the each left and right handle of the backside of the product with one hand of the each person and with the other hand, grip the bottom portion of the rear side of the product to move.

(The illustration below may differ from the actual items.)

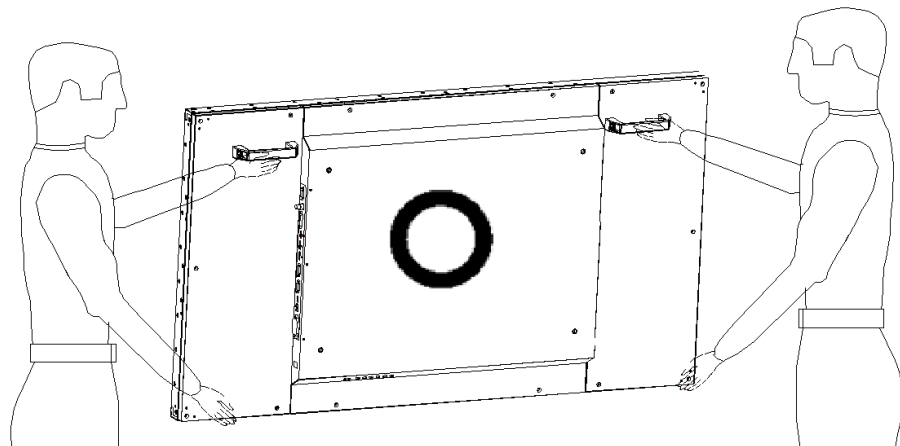

2. Wrong way

Do not use or touch any part of the front screen of the product during transportation.

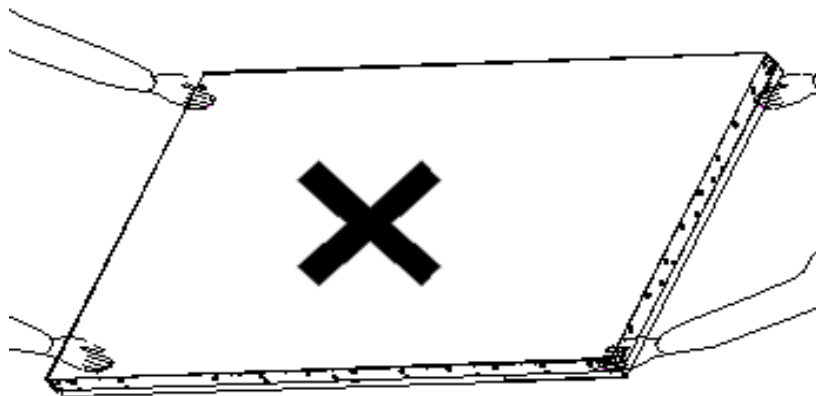

Putting a product

1. Right Way

Before putting the product on the floor, prepare flat and soft cushions. Place the product horizontally and slowly on the floor. If firstly laying the edge of the bezel of the product, the screen panel of the product may be fragile or damaged.

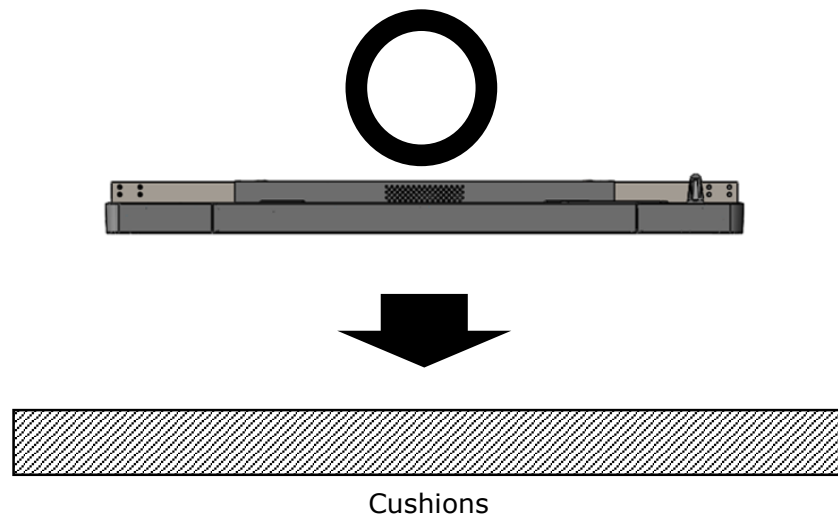

2. Wrong way

Put down carefully not to damage the outside of the product. If the corner part of the product is placed first, the bezel may be damaged easily.

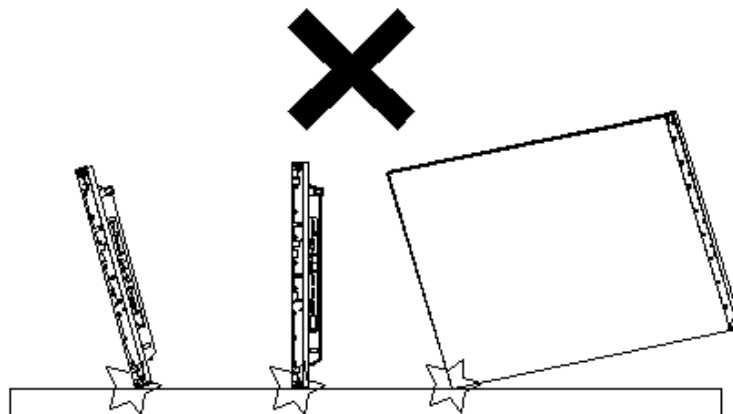

3.5 Product Installation

When installing the product with wall mount, make the product installed by a well-trained technician. Please refer to the User Guide of Wall Mounting.

 The product has VESA standard of 600 X 600 MM for wall mounting, and of M8 (maximum length of 35mm) of the screws by size.

 **Warning:** We are not responsible for the product damage or personal injury caused by user's own installation.

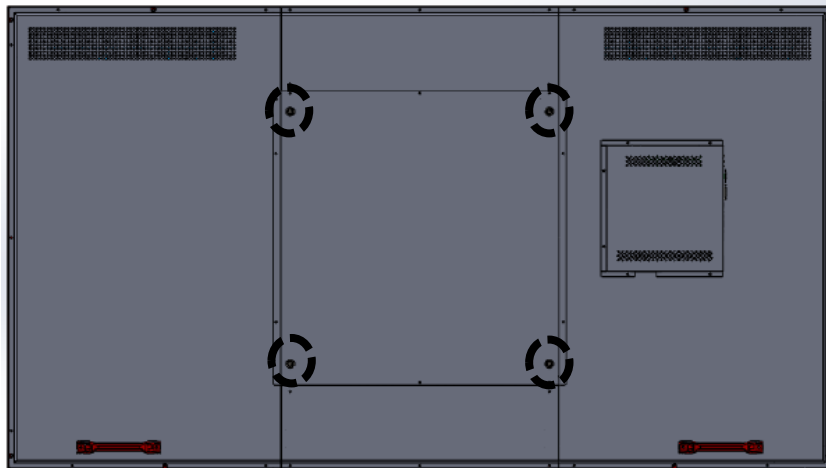

3.6 Wall mounting Installation

Install the product only on the robust and vertical wall. When installing inside the wall or cabinet, install the product with the space behind between the product and the wall as the illustration below.

Ambient temperature is kept below 35 °C.

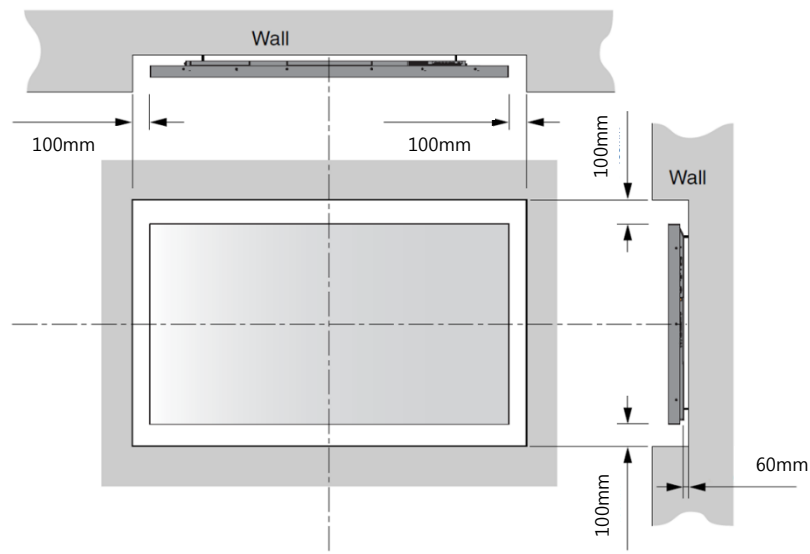

3.7 Remote Controller

Inserting batteries in the remote controller

- Press the tab on the battery case and open it.
- Insert the battery (1.5V AAA) into the battery case.
- Insert the battery case until clack sounds.

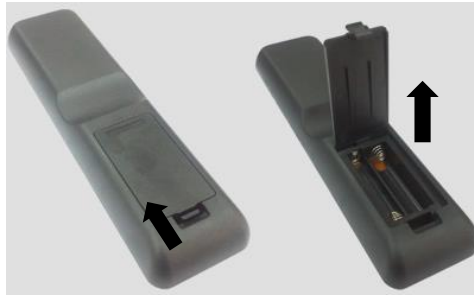

⚠ Notice on battery

- When loading the battery, check if the polarity of the batteries is correct.
- If not using the remote controller for long time, remove the batteries to prevent damage caused by battery fluid leak.
- Don't expose the battery to direct sunlight or excessive heat such as a fire.

⚠ Notes on the remote controller

- If anything interrupts in front of IR receiver or between IR receiver and remote controller, the remote controller may not work.
- If the receiving distance of the remote controller becomes narrow or does not work, replace the battery with new one.
- In case of the product is exposed to direct sunlight or fluorescent light, it may not operate.

3.8 Setup

Turning on the power

1. Connect the power cable of the product into outlet with AC 100-220V 50 / 60Hz.
2. Turn on the main AC power switch.
3. If the power indicator is green, the screen turns on automatically.
4. If the power light is red not green, press the power key on the remote controller or operate to turn on the power.

Changing language of the menu

- The language of the menu is basically English as the default set.
- Users can select a language among English, French, German, Italian, Russian, Spanish, Danish, Dutch, Norwegian, Finnish and Swedish.
- To change the menu language,
 1. Press the Menu button to go to the menu.
 2. Select the OSD from the main menu.
 3. Select the language of the OSD setup menu.
 4. Select the language you want to select, and then exit the menu.

4 Remote Control

4.1 RS-232C connection

Communication conditions

Interface	RS-232C
Pin	Txd, Rxd, Gnd
Bit rate	19200 bps
Data bits	8 bit
Parity	None
Stop bits	1 bit
Communication codes	ASCII

RS-232C Cable Pin Description



P1				P2		
Stereo 3.5Φ	Tx	1	←	2	Rx	D-SUB 9P (female)
	Rx	2	→	3	Tx	
	Gnd	3	—	5	Gnd	

Cable connection

Connect the RS-232C in port of the product to the PC or the control system.

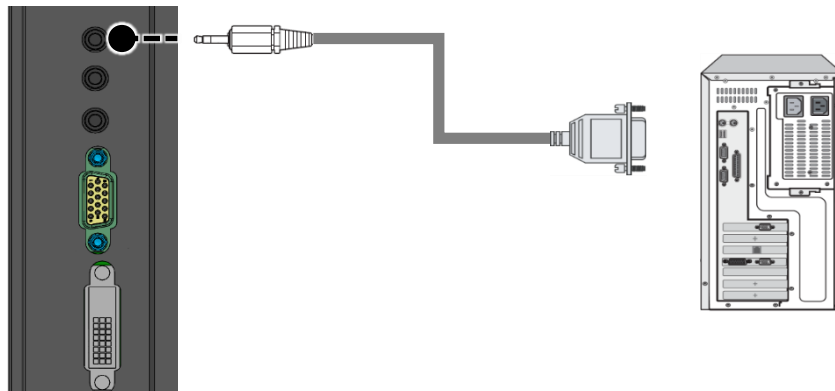

4.2 Communication Command

Direct command

It is to send a command to the product to perform the action corresponding to the command.

Statement form: [HEAD][SET ID][COMMAND][END]

Ex) Power On: [K:][ALL][PON][.] → K: ALLPON.

- [HEAD]: Represents the beginning of a statement. Put 'K:' always.
- [SET ID]: Specifies the product that perform as the command. Put 'ALL' or ID number of the product. (ID range: 000 to 100)
- [COMMAND]: It always consists of 3Bytes.
As for command, refer to page 28.
- [END]: Represents the end of a statement. Put a '.' always.

Adjustment command

It is to deliver the command which enables to adjust value in the product.

Statement form: [HEAD][SET ID][COMMAND][VALUE][END]

Ex) To adjust the volume to 50: [K:][ALL][CON][050][.]→ K: ALLCON050.

- [HEAD]: Represents the beginning of a statement. Put 'K:' always.
- [SET ID]: Specifies the product that perform as the command. Put 'ALL' or ID number of the product. (ID range: 000 to 100)
- [COMMAND]: It is always composed with 3Bytes.
As for command, refer to page 28.
- [VALUE]: Adjusted value. It consists of 3Bytes ranging from 000 to 100.
- [END]: Represents the end of a statement. Put a '.' always.

Status confirmation command

It is to send commands to the product to request reply about the command state of the product.

Statement form: [HEAD][SET ID][COMMAND][END]

Ex) Make sure if the power switch is on: [K:][ALL][PWR][?] → K: ALLPWR?

- [HEAD]: Represents the beginning of a statement. Put 'K:' always.
- [SET ID]: Specifies the product that perform as the command. Put 'ALL' or ID number of the product. (ID range: 000 to 100)

- [COMMAND]: It always consists of 3Bytes.
As for command, refer to page 28.
- [END]: Represents the end of a statement. Put a '?' always.

Reply about the status confirmation command

It is to receive a reply from the product about the status command.

Statement form: [SET ID][:][COMMAND][=][REPLY]

Ex) Power on: [ALL][:][PWR][=][001] → ALL: PWR=001

- [SET ID]: Specifies the product that perform as the command. Put 'ALL' or ID number of the product. (ID range: 000 to 100)
- [:]: Put the ':' always.
- [COMMAND]: It always consists of 3Bytes.
As for command, refer to page 28.
- [=]: Put the '=' always.
- [Reply]: Represents the end of a statement. Put a '?' always.

Command receiving status message

It is a message that the product replies about command receiving status upon direct or adjustment command message.

Normal: [SET ID][:][Command][=][A]

Error: [SET ID][:][Command][=][N]

4.3 Communication Command list

Type	Command	Value	Reply
Power off	POF		
Power on	PON		
Power status	PWR		Off : 000, On : 001
Mute off	MOF		
Mute on	MON		
Mute status	MUT		Off : 000, On : 001
Adjusting volume	VOL	000 ~ 100	000 ~ 100
Inputting image	SRC		VGA : 000, DVI:001, HDMI1:005, HDMI2, 009, DisplayPort: 006
VGA input selection	SPC		
DVI input selection	SH1		
HDMI1 input selection	SH2		
HDMI2 input selection	SH4		
DP input selection	SH3		

5 Connect the external device

5.1 DP (Display Port) Connection

- If connecting the product to the PC, it supports the VESA Display Data Channel (DDC) standard. This standard supports "plug and play" function which helps the PC recognize the product automatically to output the optimal resolution.

In order to operate the 'plug and play' after connecting the product, connect the video cable of the PC to the product before turning on your PC, and turn on the power of this product first and then turn on the power of the PC.

- When the incompatible resolution of the input signal is input to the product no image is shown on the screen or normal display is not shown. As for the supported resolutions, refer to page 42.

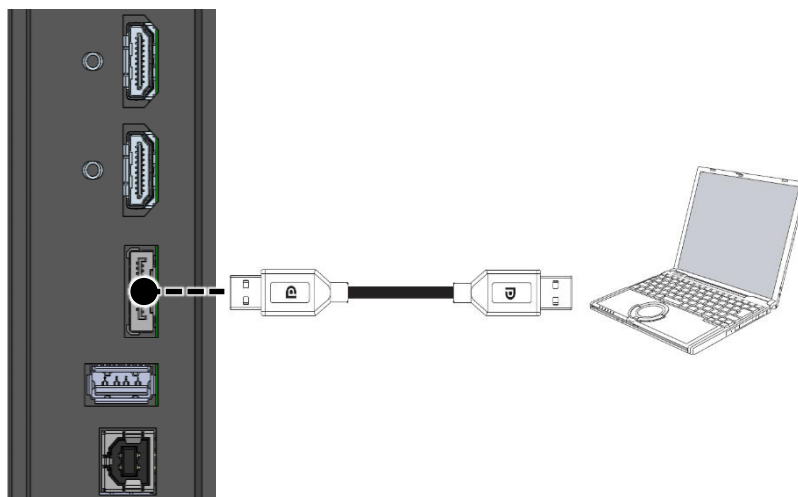

5.2 HDMI Connection

- HDMI input is recommended because it receives a digital signal input from an external device with HDMI output to ensure high quality of digital signal.

* Use the cable provided with the product. Otherwise, no image may be shown on the screen or normal display may not be shown.

- If connecting the product to the PC, it supports the VESA Display Data Channel (DDC) standard. This standard supports "plug and play" function which helps the PC recognize the product automatically to output the optimal resolution.

In order to operate the 'plug and play' after connecting the product, connect the video cable of the PC to the product before turning on your PC, and turn on the power of this product first and then turn on the power of the PC.

- When the incompatible resolution of the input signal is input to the product no image is shown on the screen or normal display is not shown. As for the supported resolutions, refer to page 42.

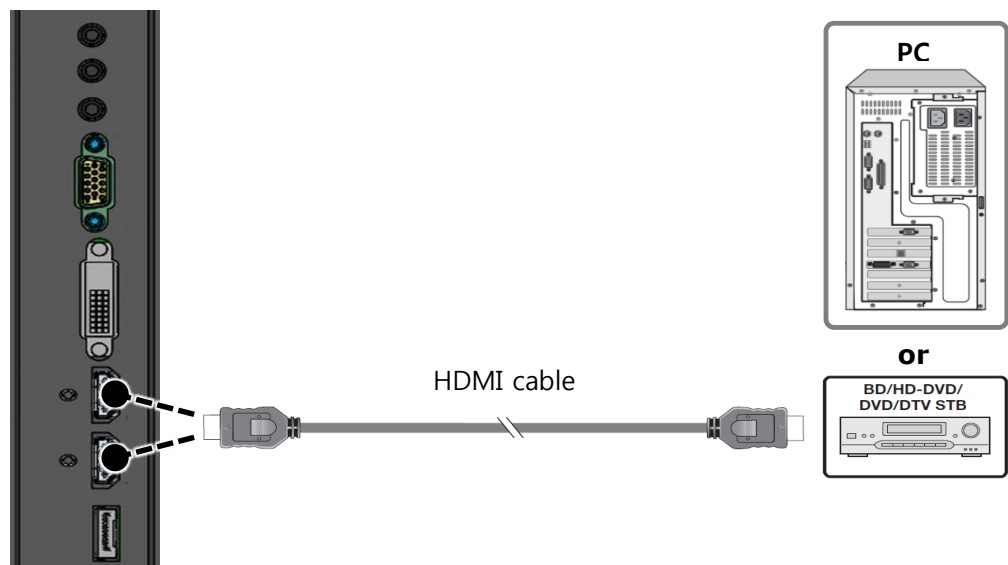

 If you receive a 3840 x 2160 30Hz input HDMI cable, please use the 4K2K certified products. The screen may look strange.

5.3 DVI-D Connection

- To see video, connect the product to a PC or an external equipment which outputs DVI video.
- If connecting the product to the PC, it supports the VESA Display Data Channel (DDC) standard. This standard supports "plug and play" function which helps the PC recognize the product automatically to output the optimal resolution.

In order to operate the 'plug and play' after connecting the product, connect the video cable of the PC to the product before turning on your PC, and turn on the power of this product first and then turn on the power of the PC.

- When the incompatible resolution of the input signal is input to the product no image is shown on the screen or normal display is not shown. As for the supported resolutions, refer to page 42.

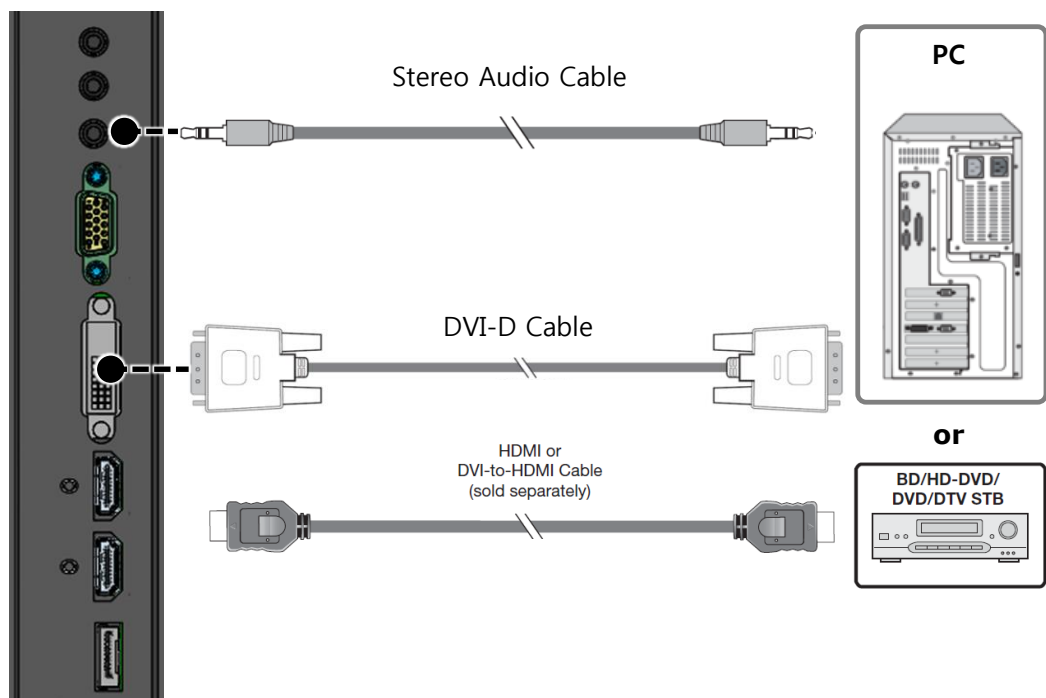

5.4 VGA Connection

- To see the video, connect D-Sub 15P cable of the PC to the VGA In port of the product.
- If connecting the product to the PC, it supports the VESA Display Data Channel (DDC) standard. This standard supports "plug and play" function which helps the PC recognize the product automatically to output the optimal resolution.

In order to operate the 'plug and play' after connecting the product, connect the video cable of the PC to the product before turning on your PC, and turn on the power of this product first and then turn on the power of the PC.

- When the incompatible resolution of the input signal is input to the product no image is shown on the screen or normal display is not shown. As for the supported resolutions, refer to page 42.

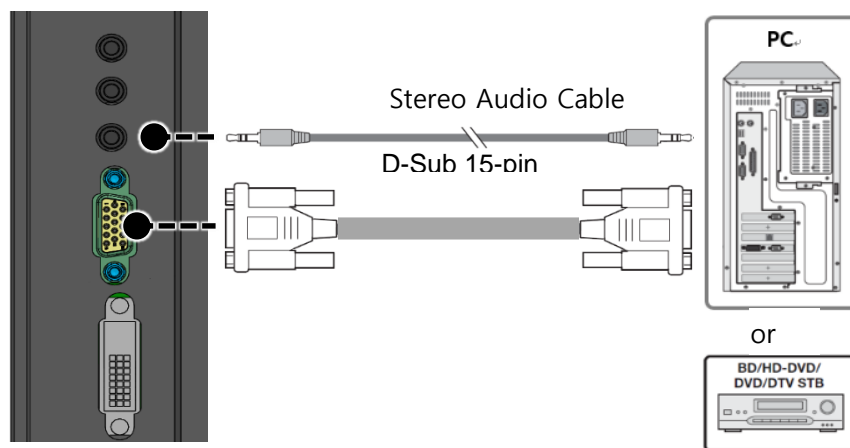

6 Menu Control

6.1 Input selection

Press the Input button and then select ▲ or ▼, or the input you want to select, and then press the ► (+) button.

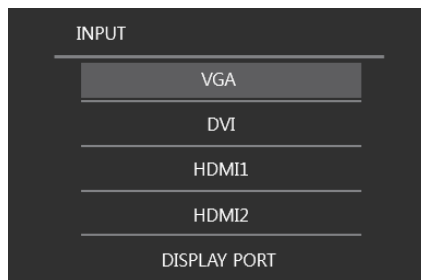

Input	Description
VGA	VGA input
DVI	DVI input
HDMI1	HDMI1 input
HDMI2	HDMI2 input
DISPLAY PORT	Display Port input

6.2 Picture Adjustment

Press the MENU button, and then press the ▲ or the ▼ button to go to the PICTURE menu. Press ► button to go to the PICTURE SETTING menu, and after moving to the menu, press the ▲ or ▼ button to the menu which you want to move and setup menu screen by pressing ►(+) or ◀(-) button, then press the MENU button to exit.

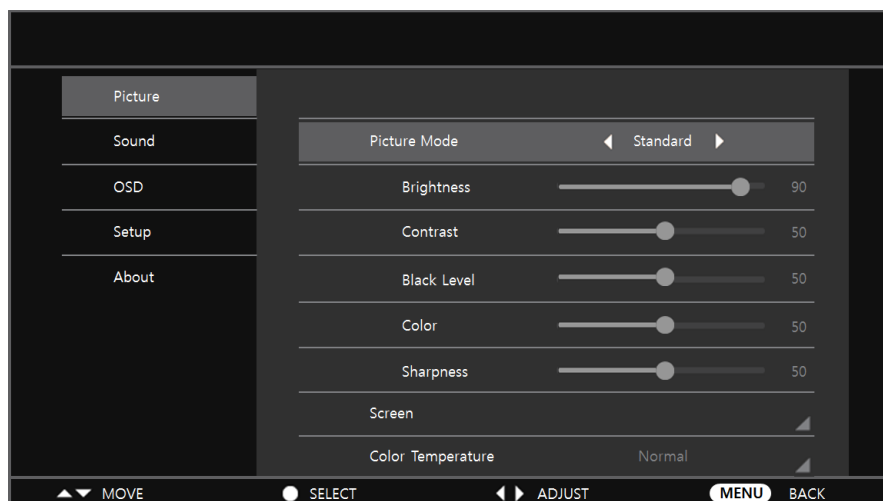

 The screen menu can be adjusted only in VGA input mode.

Menu	Sub-menu	Description
Picture Mode	Standard / User / Dynamic	To select a picture mode.
	Brightness	To adjust the brightness of the backlight.
	Contrast	To adjust the contrast of white and black.
	Black level	To adjust the brightness of the screen.
	Color	To adjust colors. If setting the value lower the greenish color gets stronger, if setting the value higher, the red color tone gets stronger.
	Sharpness	To adjust the sharpness of the screen.
Screen	Auto Adjust	To adjust location / frequency / phase of the VGA input screen automatically.
	H-Position	To adjust the horizontal position of the VGA input screen.
	V-position	To adjust the vertical position of the VGA input screen.
	Clock	To adjust the frequency of the VGA input screen.
	Phase	To adjust the phase of the VGA input screen.
Color Temp	Normal / Cool / Warm / User	To select the color temperature mode.
	Red	To adjust finely the intensity of red color.
	Green	To adjust finely the intensity of green color.
	Blue	To adjust finely the intensity of blue color.
Movie Mode	Off/Low /Medium/High	Adjust the level of vibration and blurring of the screen. 1. Off: Game or Sports 2. Low/Medium/High: Movie
Picture Reset	-	To initialize the PICURE menu.

6.3 Sound Adjustment

Press the MENU button, and then press the ▲ or the ▼ button to go to the SOUND menu. Press ► button to go to the SOUND SETTING menu, and after moving to the menu, and after moving to the menu which you want to move and setup menu sound by pressing ►(+) or ◀(-) button, then press the MENU button to exit.

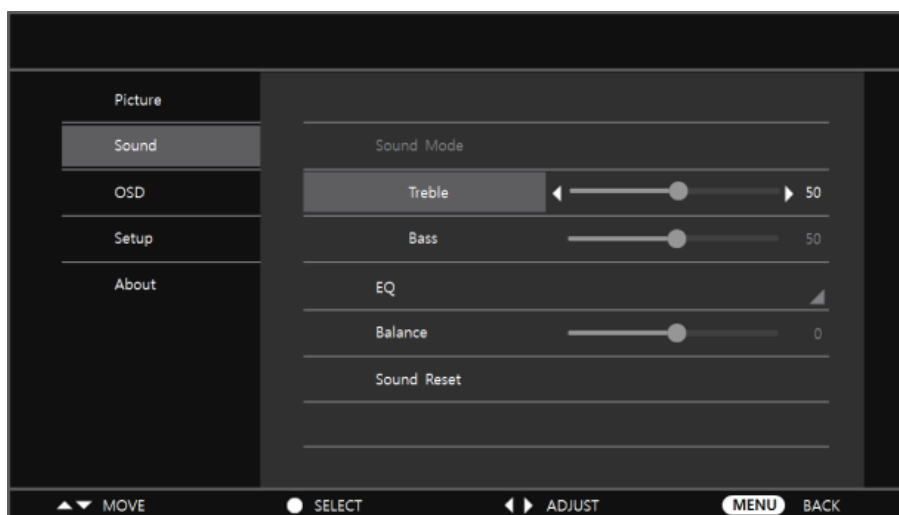

Menu	Sub-Menu	Description
Sound	Treble	To adjust the strength of treble region
	Bass	To adjust the strength of the bass region
EQ	120Hz	To adjust the strength of 120Hz
	500Hz	To adjust the strength of 500Hz
	1.2kHz	To adjust the strength of 1.2kHz
	7.5kHz	To adjust the strength of 7.5kHz
	12kHz	To adjust the strength of 12kHz
Balance	-	To adjust the left / right speaker sound balance.
Sound Reset	-	To initialize the SOUND menu

6.4 OSD Adjusting

Press the MENU button, then press the ▲ or ▼ button to go to the OSD menu. And press the ► button to go to the OSD SETTING menu and press the ▲ or ▼ button to move to a menu which you want to go to and set value by pressing the ► (+) or ◀ (-) button and then press the MENU button to exit.

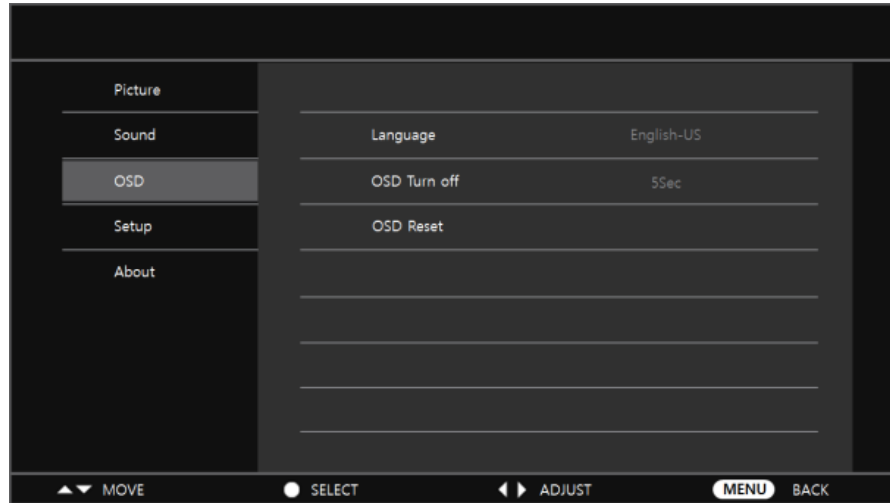

Menu	Description
Language	To set the menu language.
OSD Turn off	To adjust the display time of the OSD screen. (Off / 5 seconds / 10 seconds / 15 seconds)
OSD Reset	To reset the OSD menu.

6.5 Adjusting Setting

Press the MENU button, then press the ▲ or ▼ button to go to the Setting menu. And press the ► button to go to the Setting menu and press the ▲ or ▼ button to move to a menu which you want to go to and set value by pressing the ► (+) or ◀ (-) button and then press the MENU button to exit.

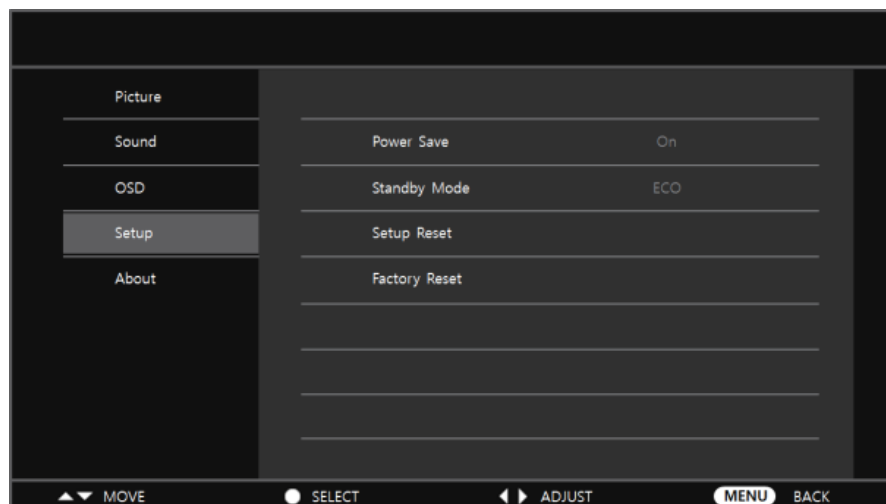

Menu	Description
Power Save	To save power consumption by setting On. In case of no input of video signal input, after 10 seconds later, the power mode changes to power consumption mode (standby mode).
Standby Mode	<p>1. ECO: When the product is in standby mode or if the product changes to be in standby mode due to absence of video signal while setting power saving mode, You can cut down on the energy by maintaining the power consumption under 0.5W. However, even though the video signal is input, the screen is not automatically turned on and you cannot turn on it by RS-232C.</p> <p>2. NORMAL: When the product is in standby mode, it maintains the power consumption under 2W. When the product changed to power saving mode due to absence of video signal, if the video signal is input, the screen is automatically turned on.</p>
Setup Reset	To initialize the SETUP menu.
Factory Reset	To reset the value of all of the set menu to the factory defaults.

6.6 Information

Press the MENU button, and then press the ▲ or the ▼ button to move to the ABOUT menu. Or press the INFO button on the remote control. Then you can check model name, ID, current input resolution and software version etc. of the product.

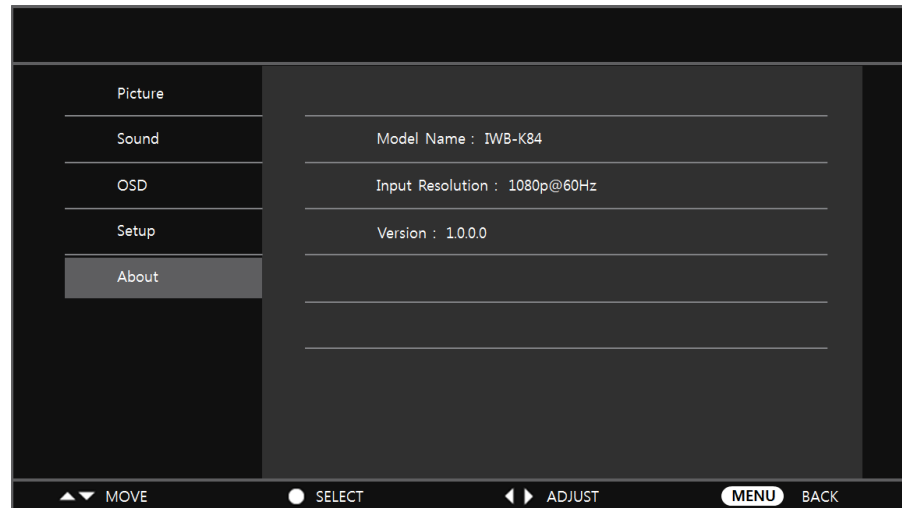

7 Troubleshooting

The table below provides some general guidelines for troubleshooting problems you may encounter with your product. If the suggested solutions fail to resolve the problem or if you encounter an issue not described here, please contact your dealer or service center.

Symptom	Checklist & Solution
The power is not turned on. (When the LED light indication is red or orange.)	<ul style="list-style-type: none"> • Turn on power switch of the product or by using remote controller, check if the product is in power saving mode for no input of video signal.
The power is not turned on. (LED indication that the light is off)	<ul style="list-style-type: none"> • Ensure that the product is plugged in and that the AC outlet is active. • Set the main power switch to the on position. • Try to connect other electric equipment to AC outlet to check if there is no problem in power source.
The remote controller does not work.	<ul style="list-style-type: none"> • Replace the battery. • If the remote controller receiver of the product is prevented by any object, delete the object and try to operate again. • If the remote controller receiver of the product is exposed to direct sunlight or strong light, try to block the light and operate again.
The power is on only but the screen does not appear.	<p>When the LED indicator of the product is green, video displays on the screen. Turn on the power of the product by using the power switch or remote controller.</p> <ul style="list-style-type: none"> • Turn off the AC power, and then turn it on again.
A message of 'Input out of range' is displayed.	<ul style="list-style-type: none"> • Check if a signal with other resolution which the product does not support is input to the product and refer to the details in the page 42.

Symptoms	Checklist
Images is not displayed correctly or noise is shown on the screen.	<ul style="list-style-type: none"> • Ensure the cables are connected in and video signal is active. • Change the cable. • Check if a signal with other resolution which the product does not support is input to the product and refer to the details in the page 42. • Connect another product to check if there is no problem, considering the possibility of problem in outer video signal equipment.
'No Signal' message is displayed.	<ul style="list-style-type: none"> • Check to see if the external signal device is turned on. • Check if computer is on power saving mode by handling the mouse or pressing keyboard to wake. • Check to see if the external signal devices and cables are connected. • Check to see if the cable connections are loose or missing out. • Try changing the cable. • Check if the input selection of products is correctly set to an external device by using the SOURCE button on the remote controller.
HDMI screen is not displayed. Or screen appears strange.	<ul style="list-style-type: none"> • Check to see if the cable connections are loose or missing out. • Try changing the cable. • If you use an HDMI cable not certified, it may result in a problem.
HDMI display is small or large visible.	<ul style="list-style-type: none"> • Try adjusting video output size of the graphic card in case of computer.

Symptoms	Checklist
The color of VGA screen is strange.	<ul style="list-style-type: none"> • Check to see if the cable connections are loose or missing out. • Try changing the cable. • Connect another product to check if there is no problem, considering the possibility of problem in outer video signal equipment.
The position of VGA screen is strange.	<ul style="list-style-type: none"> • Try adjusting the automatic position by using the AUTO button on the remote controller.
The screen is too bright and the image is not separated.	<ul style="list-style-type: none"> • From the menu, try making the value of the black level lower on the screen menu setting. • Or try to initialize the screen menu settings.
The dark area of the screen is too bright	<ul style="list-style-type: none"> • From the menu, try make the value of the contrast lower on the screen menu settings. • Or try to initialize the PICTURE settings.
Screen looks too dark.	<ul style="list-style-type: none"> • Try to initialize the PICTURE settings.

8 Product Specification

 Product specifications are subject to change without notice.

Signal Input/Output	
Horizontal / vertical frequency	Analog: 31.5 ~ 67.5 KHz / 50 ~ 71 Hz
	Digital: 31.5 ~ 91.1 KHz / 50 ~ 71 Hz
Input Resolution	1920 x 1080 @ 60 Hz (Analog / DVI) / 3840 x 2160 @ 30 Hz (HDMI / DP)
Input / output terminals	DP(DisplayPort) / HDMIx2 / DVI / VGA / PC In / Audio In / Audio Out / IR In
Communication Terminals	RS-232C In

Cosmetic	
Dimensions	1910 x 1102 x 90.5 mm
Weight	Product: 68 ± 2kg, Packing: 98 ± 3kg
Wall mount	600mm x 600mm VESA (bolt - M8)

OSD function	
Adjustment	Control buttons, IR remote control, RS-232C
Language	Korean, English, French, German, Italian, Russian, Spanish, Danish, Dutch, Norwegian, Finnish, Swedish

Power	
Power supply	AC 100V ~ 240V (50/60 Hz)
Power consumption (active state)	max 500 W
Power consumption (standby)	< 0.5 W

Operating Conditions	
Operating conditions	0°C ~ 40°C, 85% RH
Storage Conditions	-20°C ~ 60°C, 90% RH

9 Supported Resolutions

Resolution		fH (kHz)	fV (Hz)	Dot clock (MHz)	PC	DVI-D	HDMI	DisplayPort	Remark
VESA	720 x 400	31.5	70.156	26.25	O	O	O	O	
	640 x 480	31.469	59.95	25.175	O	O	O	O	
	800 x 600	37.879	60.317	40	O	O	O	O	
	1024 x 768	48.363	60.004	65	O	O	O	O	
		56.476	70.069	75	O	O	O	O	
	1280 x 768	47.396	59.995	68.25	O	O	O	O	
	1360 x 768	47.712	60.015	85.5	O	O	O	O	
	1280 x 1024	63.981	60.02	108	O	O	O	O	
		80	75	135	O	O	O	O	
1920 x 1080	67.5	60	148.5	O	O	O	O		
EDTV	480p	31.5	60	27.03		O	O	O	4:4:4 / 4:2:2 format
	576p	31.25	50	27		O	O	O	
HDTV	720p	37.5	50	74.25		O	O	O	
		44.995	59.94	74.176		O	O	O	
		45	60	74.25		O	O	O	
	1080i	28.13	50	74.25		O	O	O	
		33.716	59.94	74.175		O	O	O	
		33.75	60	74.25		O	O	O	
	1080p	56.25	50	148.5		O	O	O	
		67.432	59.95	148.35		O	O	O	
		67.5	60	148.5		O	O	O	
2160p (4Kx2K)	67.5	30	297			O	O	4:2:0 format	

10 Required information

10.1 Prevent image sticking

△ The fixed image (title, menu image, picture, motionless movie etc.) on the screen is maintained for a long time, image sticking may occur. Image sticking may be subject to operating time of still picture. Since the image sticking is not defect but a characteristic of the product, it is restricted from the product warranty.

Thus, please refer to the following information for the prevention of image sticking.

- When external device (PC) is not used for a long time, please use screensavers.
(The screensaver should be monochrome or moving image.)
- If 4:3 aspect ratio is used for a long time, image sticking might occur.
So, it is recommended to use the full screen.
- In case of displaying still picture for long time, change pictures a certain time.

If image sticking is shown, turn off the unit for a while and turn it on again.
Turn off time may be required according to degree of image sticking.



IDIS Co., Ltd.

For more information, please visit at
www.idisglobal.com